



Rhode Island

Web Services for an Internet Resource Directory and Benefits Screeners

Using Internet web services to find community support and checking for a citizen's potential eligible programs.

Rhode Island Dept. of Human Services - Center for Adult Health

September 26, 2006

Topics



- Web Services Overview
- The 2 Applications
 - Resource Directory
 - Benefits Screener
- Web Services Technology
- Our Experience

Introduction

- Rhode Island Dept. of Human Services
- Project funded by CMS Real Choices Grant
- Developed and hosted by two vendors

Web Services Overview

- SOA – Service Oriented Architecture
- Web services a vital component of SOA
- How many have used web services in your organization?

What Web Services Do:

Integrate

&

Share Data

Data Locked Away

Neither websites have access to data

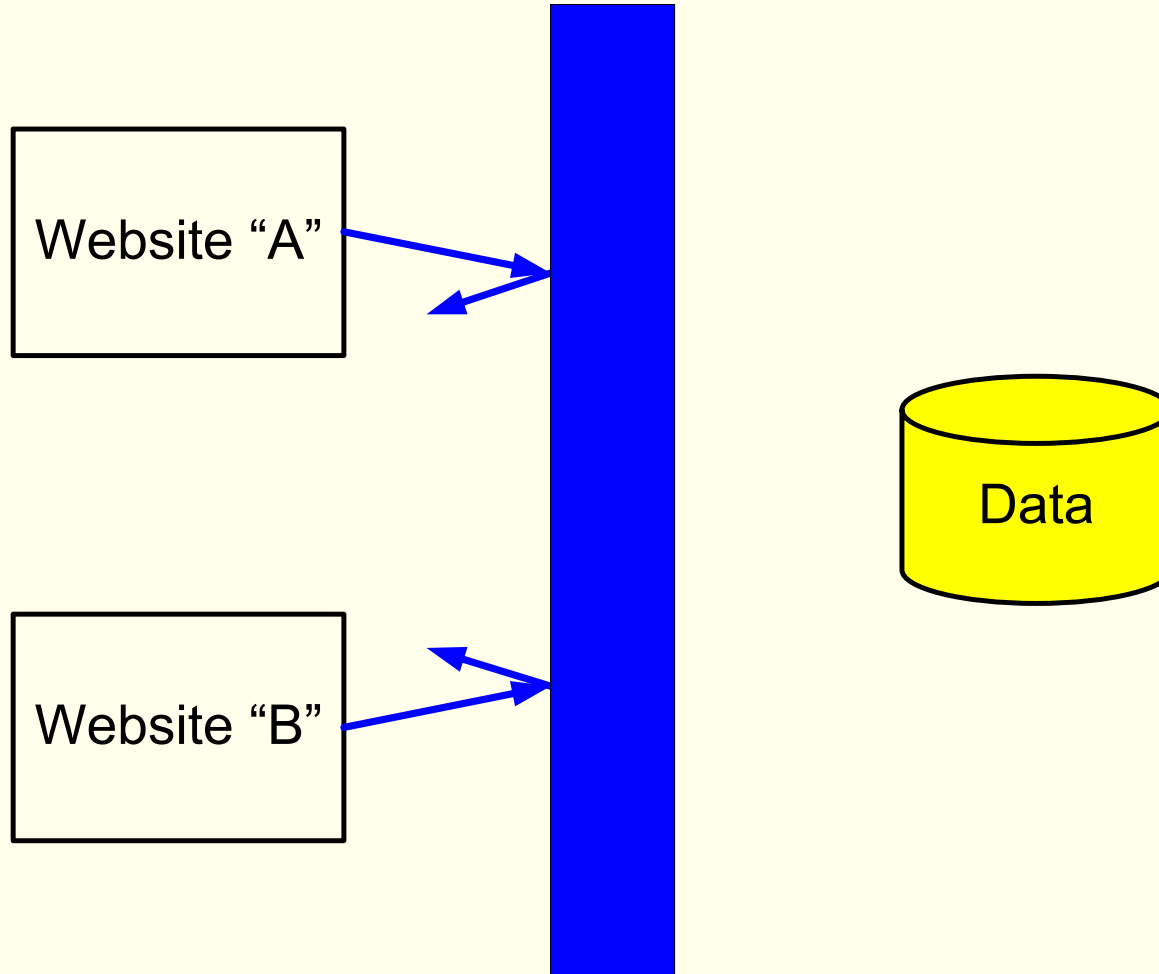

One Website Gets Access

One has full access, Website "A" must link over to Website "B" for access

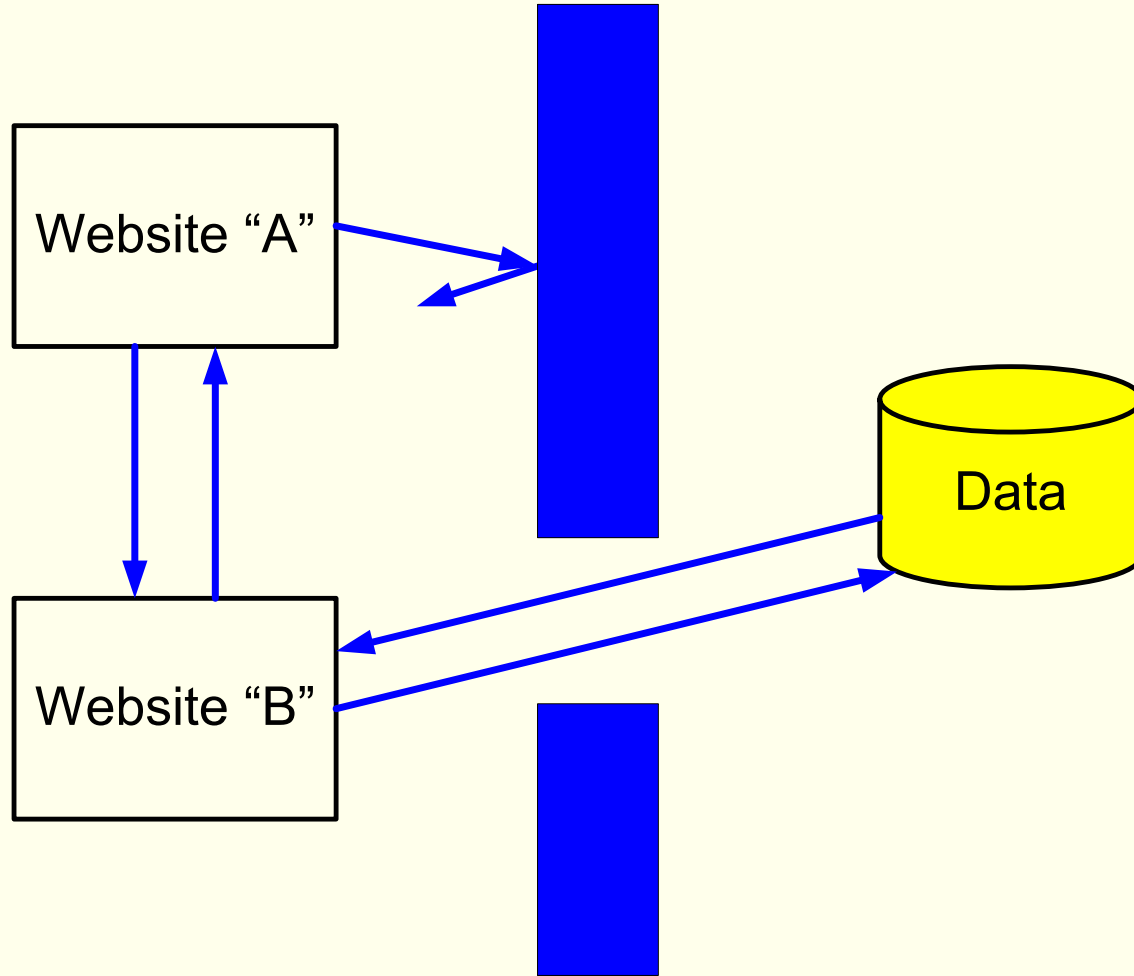

Both Website Get Access

Both websites get full access via web services

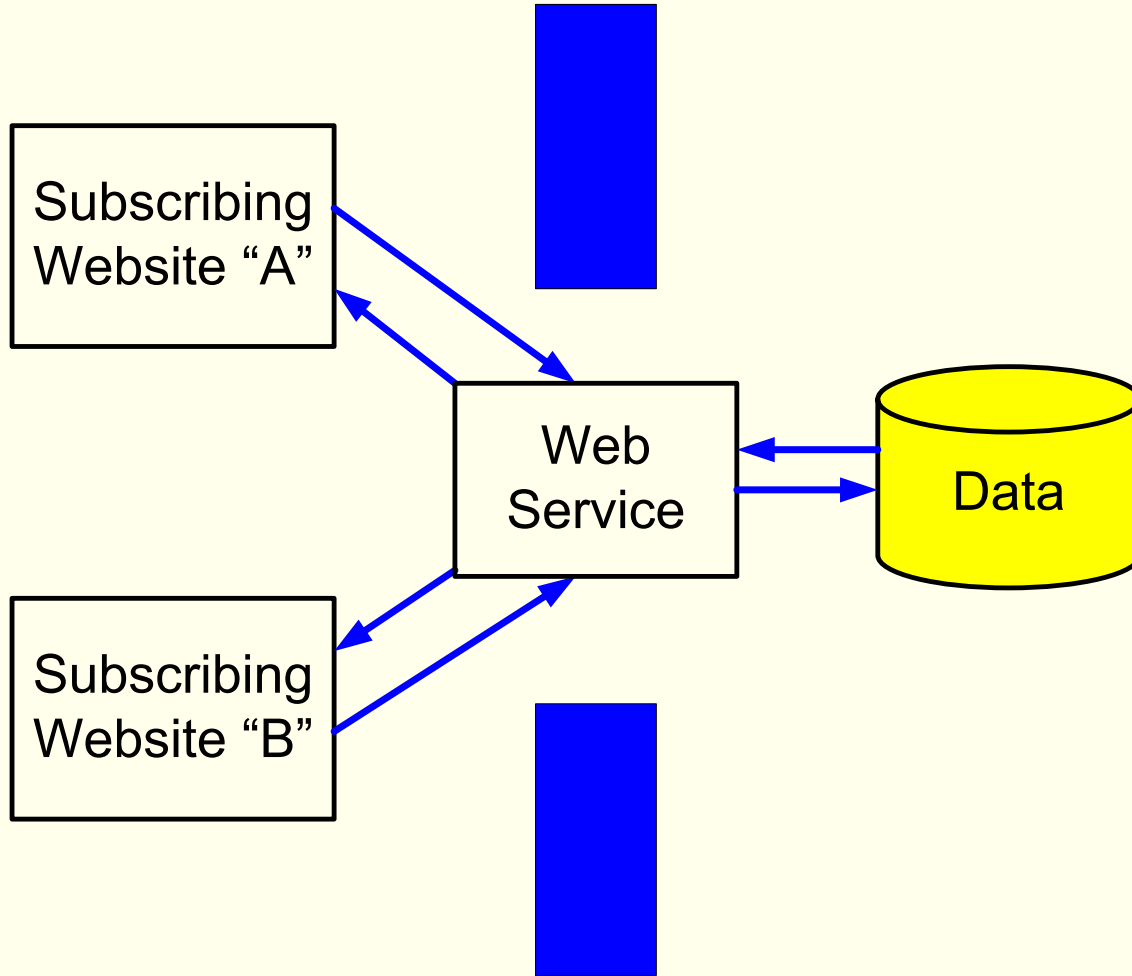

Web Services Overview

- MITA and Web Services
- Web services: the “in-between” link to reach locked-away data

Unshared Website Use

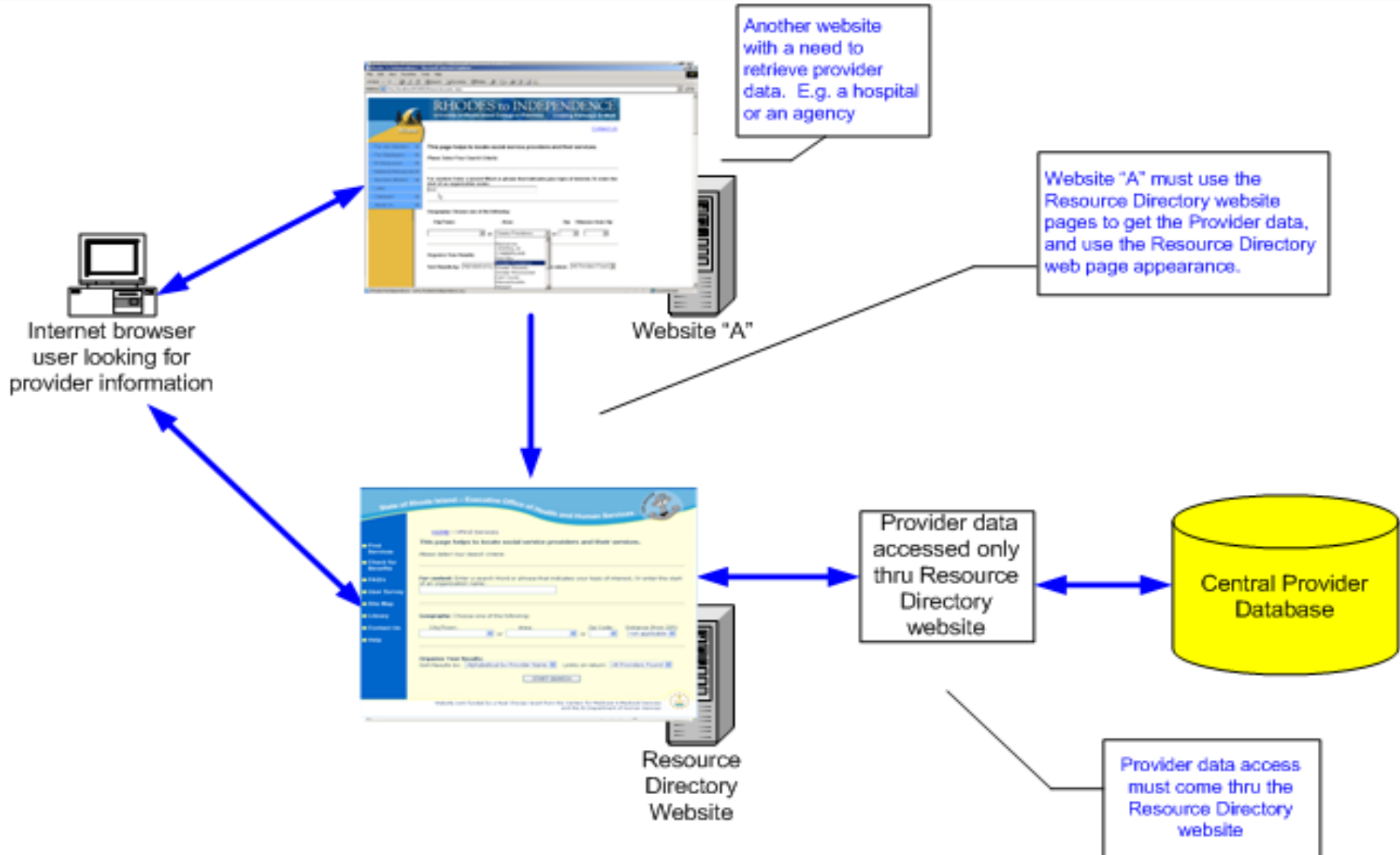

Shared Web Services Use

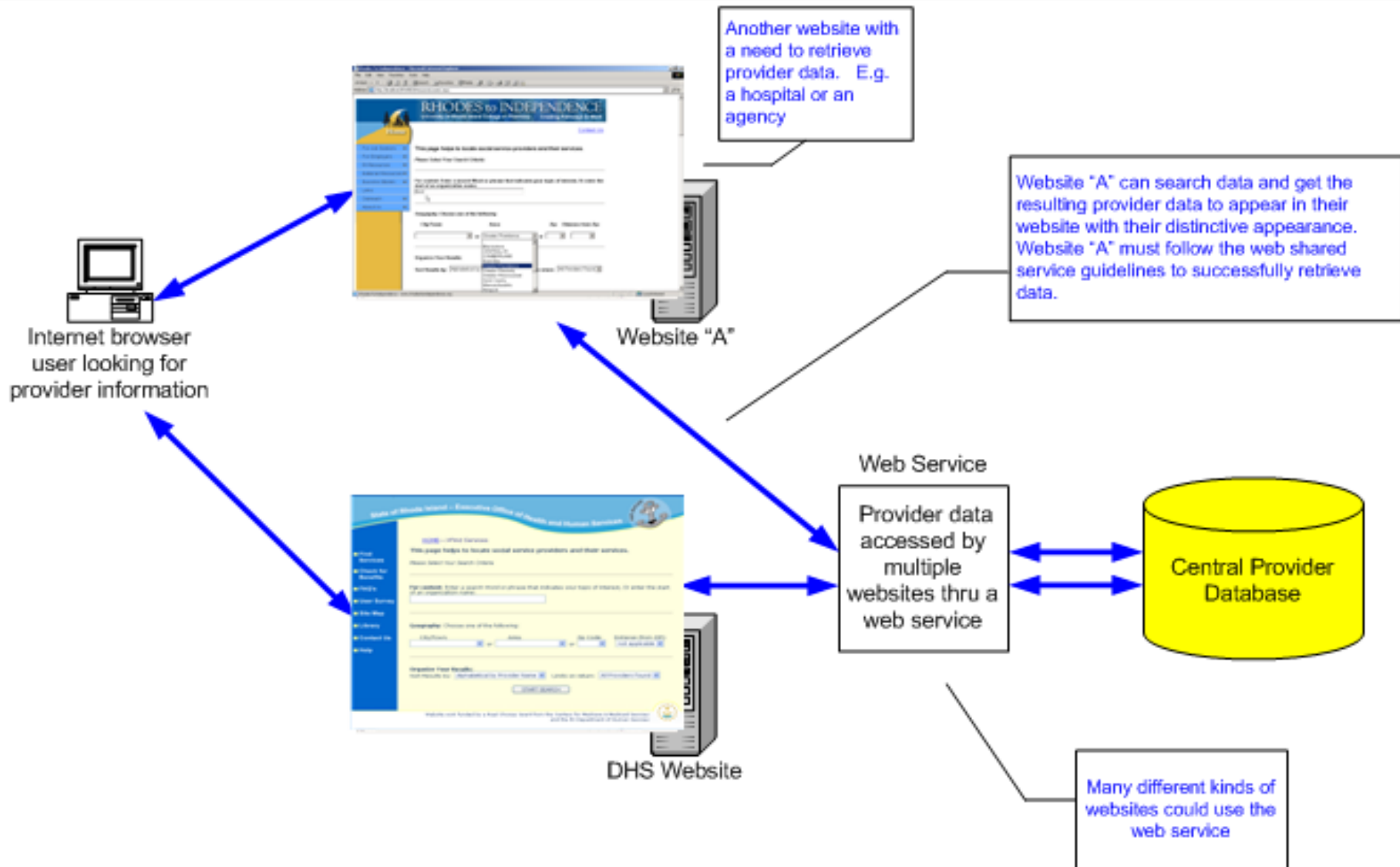

The AskRhody Website

State of Rhode Island – Executive Office of Health and Human Services



[HOME](#)-->Find Services

This page helps to locate social service providers and their services.

Please Select Your Search Criteria

- Find Services
- Check for Benefits
- FAQ's
- User Survey
- Site Map
- Library
- Contact Us
- Help

For content: Enter a search Word or phrase that indicates your topic of interest, Or enter the start of an organization name:

Geography: Choose one of the following:

City/Town: or Area: or Zip Code: Distance (from ZIP):

Organize Your Results:

Sort Results by: Limits on return:

START SEARCH



"Subscribing" Website

Rhodes To Independence - Microsoft Internet Explorer

File Edit View Favorites Tools Help

Address <http://localhost/RIWEB2/ResourceLocator.aspx> Go



University of Rhode Island College of Pharmacy Creating Pathways to Work

[Home](#) [Contact Us](#)

- For Job Seekers
- For Employers
- RI Resources
- National Resources
- Success Stories
- Links
- Outreach
- About Us

This page helps to locate social service providers and their services.

Please Select Your Search Criteria:

For content: Enter a search Word or phrase that indicates your topic of interest, Or enter the start of an organization name:

Geography: Choose one of the following

City/Town:	Area:	Zip:	Distance from Zip:
<input type="text"/>	Greater Providence	<input type="text"/>	<input type="text"/>

Organize Your Results:

Sort Results by: On return:

- Blackstone
- CENTRAL RI
- CUMBERLAND
- East Bay
- Greater Providence
- Greater Westerly
- Greater Woonsocket
- Kent County
- Massachusetts
- Newport

RhodesToIndependence - www.rhodesindependence.org Local intranet

Background

- The Two Applications
 - Resource Directory – find service organizations via a “Google-style” search
 - Benefits Screener – answers the question: “Might I qualify for DHS state-funded programs?”
- For:
 - Citizens
 - Caregivers
 - Providers
 - Government Workers
 - For-profit & Not-for-profit organizations

Resource Directory



- “Google-style” service searching
- Search by RI geography
- 3,300 organizations in database
- Now in English. Will soon be in Spanish and Portuguese

Resource Directory

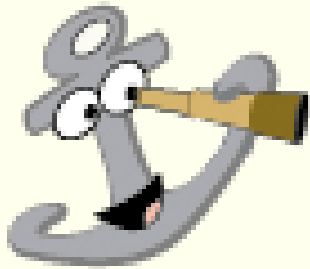

- Three Steps to Detailed Information
 - Search
 - List
 - Details

1. Search for "housing"

State of Rhode Island – Executive Office of Health and Human Services



[HOME](#)-->Find Services

This page helps to locate social service providers and their services.

Please Select Your Search Criteria

For content: Enter a search Word or phrase that indicates your topic of interest, Or enter the start of an organization name:

Geography: Choose one of the following:

City/Town: or Area: or Zip Code: Distance (from ZIP):

Organize Your Results:

Sort Results by: Limits on return:

Website work funded by a Real Choices Grant from the Centers for Medicare & Medicaid Services and the RI Department of Human Services



How the search works

- Searches for name of organization
- Searches for service descriptions (like "housing")

2. List



[HOME](#)-->[Find Services](#)-->Resource Results

Search for "housing" in Greater Providence
157/157 records returned/records available (search time: 0 ms)

Name	Address	Languages Spoken	Date Of Last Update
1890 House	Providence, RI 02903 (401) 521-1031		Jul 12, 2006
315 Park Avenue	Cranston, RI 02905 (401) 781-3188		Jul 12, 2006
Aaron Briggs	Providence, RI 02907 (401) 331-2832	Spanish	Jul 12, 2006
Aime Forand Manor	Johnston, RI 02919 (401) 231-2007		Jul 12, 2006
Allendale Manor	North Providence, RI 02911 (401) 728-0930		Jul 12, 2006
Amen Inc	Providence, RI 02907 (401) 831-0367		Jul 12, 2006
Amos House	Providence, RI 02907 (401) 272-0220		Jul 27, 2006
Ann's Rest Home Inc	Providence, RI 02907 (401) 421-7576		Jul 12, 2006
Another Way for Women	Providence, RI 02908 (401) 621-7143		Jul 12, 2006

■ Find Services

■ Check for Benefits

■ FAQ's

■ User Survey

■ Site Map

■ Library

■ Contact Us

■ Help

3. Details of provider



[HOME](#)-->[Find Services](#)-->
[Resource Results](#)-->Resource Detail

- Find Services
- Check for Benefits
- FAQ's
- User Survey
- Site Map
- Library
- Contact Us
- Help

Provider Name Amos House

Phone	Desc	Type
(401) 272-0220	Dining Room/Main Office	Main Phone
(401) 274-8021	Social Services	Other
(401) 272-2137		Other Fax

Address 415 Friendship Street

City, State, Zip Providence, RI 02907

Map Info [Click for map of Organization's location](#)

Languages Spoken

Website url www.amoshouse.com

Provider Description Services: Transitional housing for 18 men and nine women; referrals and social support services. Free medical clinic and eye clinic. Prescription assistance.

Income Source: Donations; United Way

Hours of Operation 8am-4pm, M - Fr, social services; 7am-8am, M - Fr,

Areas Served Greater Providence

Fees none

Accessibility Information Accessible Entrance
Accessible Restrooms

List of Services Case/Care Management
Clothing
Crisis Shelter
Emergency Shelter
Homeless Drop In Centers
Homeless Family Reunification Services
Homeless Financial Assistance Programs
Homeless Shelter
Housing Search and Information
Housing Search Assistance
Housing/Shelter
Information and Referral
Information and Referral Associations
Information Lines

The Data

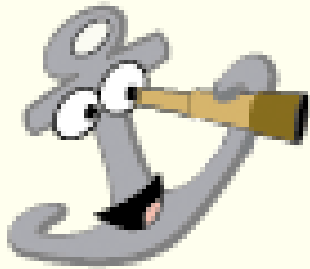

- Initial data contributed by Crossroads & DHS
- Data administration done via the web
- RI DHS, its sister agencies, and Crossroads can administer data electronically

Benefits Screener

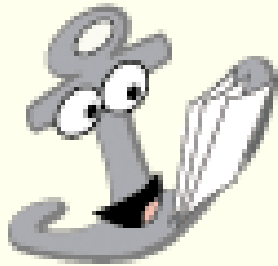

- Five programs now, more to be added
 - QMB - Medicare Payment Help
 - SLMB
 - QI-1
 - RIPAE – Drug Payment Assistance
 - Community Support Co-pay
- Screener, not an eligibility determination

Benefits Screener



- Three steps to benefits screening
 - Choose programs
 - Enter data
 - Get results

1. Choose programs

State of Rhode Island – Executive Office of Health and Human Services



[HOME](#)-->Check for Benefits

This page can check to see if a person might be qualified for several state-funded programs through entry of non-personal information.

After you select the Programs of interest, and click the Submit button, a list of questions will appear for the selected programs.

- Rhode Island Pharmaceutical Assistance to the Elderly (RIPAE)
- Qualified Medicare Beneficiary (QMB)
- Specified Low Income Beneficiary (SLMB)
- Community Support Copay Program (CSCopay)
- Qualifying Individual-1 (QI-1)

- Find Services
- Check for Benefits
- FAQ's
- User Survey
- Site Map
- Library
- Contact Us
- Help

Website work funded by a Real Choices Grant from the Centers for Medicare & Medicaid Services and the RI Department of Human Services



2. Data entry

State of Rhode Island – Executive Office of Health and Human Services



[HOME](#)-->[Check for Benefits](#)-->Benefits Screener Questions

Please answer the following questions and click the 'Check for Eligibility' button to see if you may be eligible for QMB , SLMB or QI-1

1. Total Assets
2. Annual Income
3. check if Married
4. check if Rhode Island Resident

- Find Services
- Check for Benefits
- FAQ's
- User Survey
- Site Map
- Library
- Contact Us
- Help



3. Screening results



- Find Services
- Check for Benefits
- FAQ's
- User Survey
- Site Map
- Library
- Contact Us
- Help

[HOME](#)-->[Check for Benefits](#)-->
[Benefits Screener Questions](#)-->[Benefits Results](#)

Based on the [information you entered...](#)

QMB You appear to be eligible.

[Application Instructions](#)
[Application Forms](#)

SLMB : You do not appear to be eligible.

[Application Instructions](#)
[Application Forms](#)

QI-1 : You do not appear to be eligible.

Your monthly income is not in the proper range.
[Application Instructions](#)
[Application Forms](#)

Your inputs:

1. Total Assets
2. Annual Income
3. check if Married
4. check if Rhode Island Resident

Note: You have NOT applied for this program as a result of your use of this site.
Please be sure that your information was complete and accurate.



Web Service Technology

- Development
 - Programming language used: Java
 - Development Environment: Websphere
- Deployment
 - Web Server: Microsoft IIS
 - IBM Websphere Application Server
 - Microsoft SQL Server 2005 Database

Server Setup

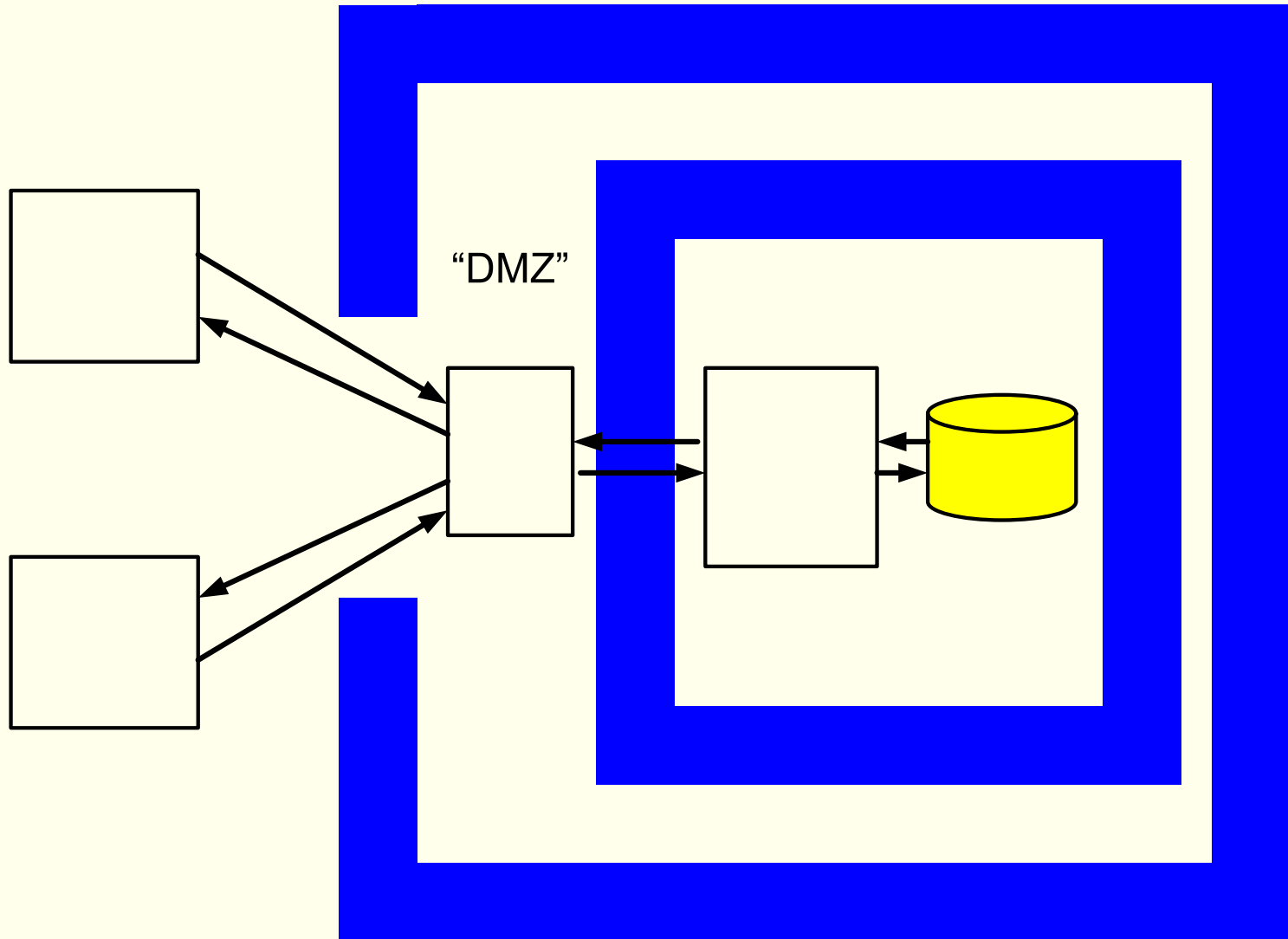

Subscribing Websites

- “Subscribing” websites need:
 - Application server like IBM Websphere or Microsoft .NET Framework
 - Knowledge of HTML

WSDL

- WSDL is a document in XML
- WSDL describes the web service
- WSDL describes the web service location
- WSDL describes how to give and get data from the web service

What does WDSL look like?

WSDL describes the web service

```
<?xml version="1.0" encoding="UTF-8" ?>
- <wsdl:definitions targetNamespace="http://ridatabase" xmlns:impl="http://ridatabase"
  xmlns:intf="http://ridatabase" xmlns:soapenc="http://schemas.xmlsoap.org/soap/encoding/"
  xmlns:tns2="http://ridhs" xmlns:wsdl="http://schemas.xmlsoap.org/wsdl/"
  xmlns:wsdlsoap="http://schemas.xmlsoap.org/wsdl/soap/" xmlns:ws-i="http://ws-
  i.org/profiles/basic/1.1/xsd" xmlns:xsd="http://www.w3.org/2001/XMLSchema">
- <wsdl:types>
- <schema targetNamespace="http://ridatabase" xmlns="http://www.w3.org/2001/XMLSchema"
  xmlns:impl="http://ridatabase" xmlns:intf="http://ridatabase"
  xmlns:soapenc="http://schemas.xmlsoap.org/soap/encoding/" xmlns:tns2="http://ridhs"
  xmlns:wsdl="http://schemas.xmlsoap.org/wsdl/"
  xmlns:xsd="http://www.w3.org/2001/XMLSchema">
  <import namespace="http://ridhs" />
  <import namespace="http://schemas.xmlsoap.org/soap/encoding/" />
  <element name="AIRScore" nillable="true" type="xsd:string" />
- <complexType name="ArrayOf_xsd_string">
- <complexContent>
- <restriction base="soapenc:Array">
  <attribute ref="soapenc:arrayType" wsdl:arrayType="xsd:string[]" />
  </restriction>
  </complexContent>
</complexType>
- <complexType name="ArrayOf_tns2_AIRSref">
- <complexContent>
- <restriction base="soapenc:Array">
  <attribute ref="soapenc:arrayType" wsdl:arrayType="tns2:AIRSref[]" />
  </restriction>
  </complexContent>
</complexType>
  <element name="OrgGroup" nillable="true" type="xsd:string" />
  <element name="OrgCategory" nillable="true" type="xsd:string" />
  <element name="ArrayOf_xsd_string" nillable="true" type="impl:ArrayOf_xsd_string" />
```

Web Service Implications

- Relatively new web services technology
- Shared services mindset
- More negotiations required between parties

Web Service Experience

- Business needs drive design
- Implement in stages
- Small team
- Collaboration key



Discussion & Questions

Web Services for an Internet Resource Directory and Benefits Screener

www.dhs.ri.gov/askrhody

Rhode Island Dept. of Human Services - Center for Adult Health
Art Schnure – aschnure@dhs.ri.gov